

*MACO[®], APLI[®] and
much more*

- *Laser and Ink Jet Labels*
- *Copier Labels*
- *CD Labels and Accessories*
- *Fluorescent and Pastel Labels*
- *Bates Labels*
- *Postage Meter Tape*
- *Lots More...*

Compare and Save!

Laser, Ink Jet and Copier Labels

Walsh
Envelope
Company

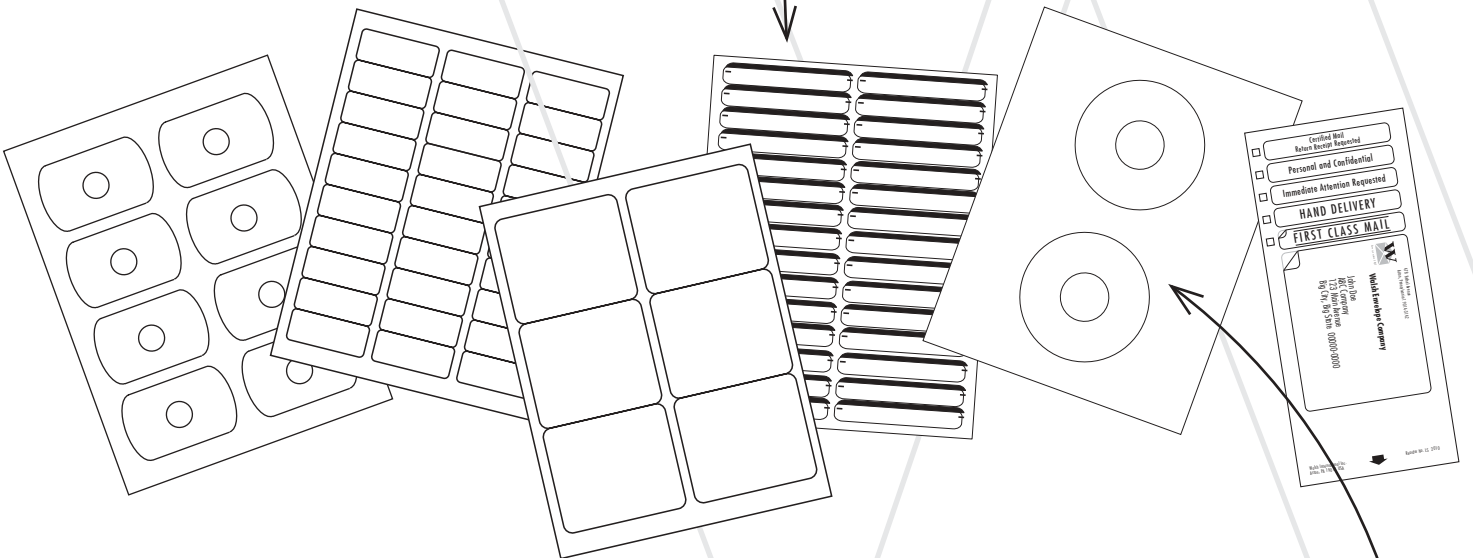

www.walshenvelopes.com

Item Number	Description	Size Inches	Corresponding No. Avery/Dennison	Qty. Labels/ Retail Pkg.	Your Cost
-------------	-------------	-------------	----------------------------------	--------------------------	-----------

All-Purpose Labels – Laser and Ink Jet Compatible

ML-3025
ML-3000
ML-3000B

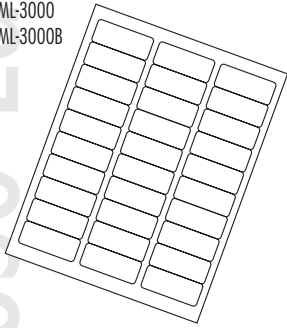

WHITE - 25 SHEETS PER PACKAGE (ALL PURPOSE)

ML-8025	80 Per Sheet	½ x 1¼	5267	2000	\$6.45
ML-3025	30 Per Sheet	1 x 2½	5260	750	\$6.45
ML-2425	24 Per Sheet	1½ diameter	5293	600	\$6.45
ML-2025	20 Per Sheet	1 x 4	5261	500	\$6.45
ML-1425	14 Per Sheet	1½ x 4	5262	350	\$6.45
ML-1225	12 Per Sheet	2½ diameter	5294	300	\$6.45
ML-1025	10 Per Sheet	2 x 4	5263	250	\$6.45
ML-0625	6 Per Sheet	3½ x 4	5264	150	\$6.45
ML-0125	1 Per Sheet	8½ x 11	5265	25	\$6.45

Bates Labels

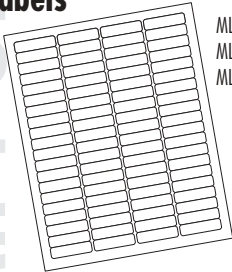

ML-8025
ML-8100
ML-8025B

WHITE - 100 SHEETS PER BOX (ALL PURPOSE)

ML-8100	80 Per Sheet	½ x 1 ¾	5167	8000	\$17.60
ML-5000	50 Per Sheet	1 x 1½	—	5000	\$17.60
ML-3000	30 Per Sheet	1 x 2½	5160	3000	\$15.65
ML-2000	20 Per Sheet	1 x 4	5161	2000	\$15.65
ML-1450	14 Per Sheet	1½ x 4	5159	1400	\$17.60
ML-1400	14 Per Sheet	1½ x 4	5162	1400	\$15.65
ML-1000	10 Per Sheet	2 x 4	5163	1000	\$15.65
ML-0600	6 Per Sheet	3½ x 4	5164	600	\$15.65
ML-0400	4 Per Sheet	5½ x 4¼	—	400	\$17.60
ML-0200	2 Per Sheet	5½ x 8½	—	200	\$17.60
ML-0100	1 Per Sheet	8½ x 11	5165	100	\$15.65

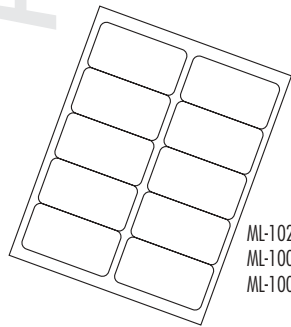

ML-1025
ML-1000
ML-1000B

WHITE - BULK PACKED FOR CONVENIENCE - 250 SHEETS PER BOX (ALL PURPOSE)

ML-8025B	80 Per Sheet	½ x 1¼	—	20000	\$41.00
ML-3000B	30 Per Sheet	1 x 2½	5160B	7500	\$38.00
ML-2000B	20 Per Sheet	1 x 4	5161B	5000	\$38.00
ML-1400B	14 Per Sheet	1½ x 4	5162B	3500	\$38.00
ML-1000B	10 Per Sheet	2 x 4	5963	2500	\$38.00
ML-0600B	6 Per Sheet	3½ x 4	—	1500	\$38.00

FILE FOLDER LABELS - 25 SHEETS PER PACKAGE (ALL PURPOSE)

ML-FF30	Assorted *	30 Per Sheet	⅔ x 3⅞	5266	750	\$13.85
---------	------------	--------------	--------	------	-----	---------

*5 sheets each: Red, Blue, Green, Yellow and White.

FILE FOLDER LABELS - 50 SHEETS PER BOX (ALL PURPOSE)

ML-FF31	White	30 Per Sheet	⅔ x 3⅞	5366	1500	\$19.25
ML-FF32	Red	30 Per Sheet	⅔ x 3⅞	5066	1500	\$19.25
ML-FF33	Yellow	30 Per Sheet	⅔ x 3⅞	5966	1500	\$19.25
ML-FF34	Light Blue	30 Per Sheet	⅔ x 3⅞	—	1500	\$19.25
ML-FF35	Dark Blue	30 Per Sheet	⅔ x 3⅞	5766	1500	\$19.25
ML-FF36	Green	30 Per Sheet	⅔ x 3⅞	5866	1500	\$19.25
ML-FF37	Orange	30 Per Sheet	⅔ x 3⅞	—	1500	\$19.25
ML-FF38	Black	30 Per Sheet	⅔ x 3⅞	—	1500	\$19.25

FILE FOLDER LABELS - 250 SHEETS PER PACKAGE (ALL PURPOSE)

BLL-FF66W	White	30 Per Sheet	⅔ x 3⅞	—	7500	\$50.00
BLL-FF66*	Color	30 Per Sheet	⅔ x 3⅞	—	7500	\$55.00

*Specify color when ordering: Red, Green, Blue, Yellow or Assorted.

ML-FF30
ML-FF66

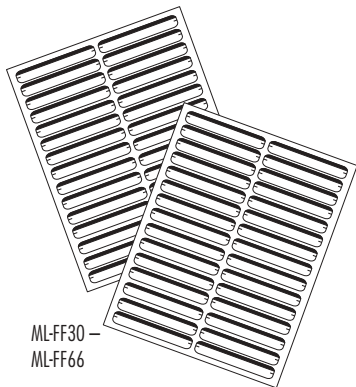

File Folder Labels

Item Number	Description	Size Inches	Corresponding No. Avery/Dennison	Qty. Labels/ Retail Pkg.	Your Cost
REMOVABLE/REPOSITIONABLE LABELS – 25 SHEETS PER BOX (ALL PURPOSE)					
RL-6000	30 Per Sheet	1 x 2 $\frac{1}{2}$	6460	750	\$14.50
RL-6004	6 Per Sheet	3 $\frac{1}{2}$ x 4	6464	150	\$14.50
RL-6020	3.5" Diskette 15 Per Sheet	2 $\frac{1}{8}$ x 2	6490	375	\$14.50

NAME BADGE LABELS - 50 SHEETS PER BOX (ALL PURPOSE)

ML-7000*	White	8 Per Sheet	2 $\frac{1}{2}$ x 3 $\frac{1}{2}$	5395	400	\$24.20
ML-7001	Red Border	8 Per Sheet	2 $\frac{1}{2}$ x 3 $\frac{1}{2}$	5095	400	\$24.20
ML-7002	Blue Border	8 Per Sheet	2 $\frac{1}{2}$ x 3 $\frac{1}{2}$	5895	400	\$24.20

Bulk packs of 100 - 250 sheets available.

Transparent Labels

TRANSPARENT LABELS - 25 SHEETS PER BOX (LASER PRINTER ONLY)

ML-4008	80 Per Sheet	$\frac{1}{2}$ x 1 $\frac{3}{4}$	5667	2000	\$30.60
---------	--------------	---------------------------------	------	------	---------

TRANSPARENT LABELS - 50 SHEETS PER BOX (LASER PRINTER ONLY)

ML-4000	30 Per Sheet	1 x 2 $\frac{1}{2}$	5660	1500	\$35.80
ML-4001	20 Per Sheet	1 x 4 $\frac{1}{4}$	5661	1000	\$35.80
ML-4002	14 Per Sheet	1 $\frac{1}{2}$ x 4 $\frac{1}{4}$	5662	700	\$35.80
ML-4003	10 Per Sheet	2 x 4 $\frac{1}{4}$	5663	500	\$35.80
ML-4004	6 Per Sheet	3 $\frac{1}{2}$ x 4 $\frac{1}{4}$	5664	300	\$35.80
ML-4005	1 Per Sheet	8 $\frac{1}{2}$ x 11	—	50	\$35.80

TRANSPARENT LABELS - 100 SHEETS PER BOX (LASER PRINTER ONLY)

MLL-2561 Clear	30 Per Sheet	1 x 2 $\frac{1}{2}$	—	3000	\$60.00
MLL-4213 Clear	14 Per Sheet	4 $\frac{1}{4}$ x 1 $\frac{1}{2}$	—	1400	\$60.00
MLL-4220 Clear	10 Per Sheet	4 $\frac{1}{4}$ x 2	—	1000	\$60.00
MLL-8511 Clear	1 Per Sheet	8 $\frac{1}{2}$ x 11	—	100	\$60.00

TRANSPARENT LABELS ON A4 SIZE SHEETS - 8.268" X 11.693" - 10 SHEETS PER PACKAGE (INK JET PRINTER ONLY)

10050	44 Per Sheet	1.9095 x .9996	—	440	\$18.50
10051	24 Per Sheet	2.756 x 1.457	—	240	\$18.50
10052	14 Per Sheet	3.891 x 1.499	—	140	\$18.50
10053	1 Per Sheet	8.268 x 11.693	—	10	\$18.50

Fluorescent and Tinted Labels for Laser Printers Only

FLUORESCENT LABELS - 15 SHEETS PER PACKAGE (LASER PRINTER ONLY)

ML-8000	Assorted	30 Per Sheet	1 x 2 $\frac{1}{2}$	5979	450	\$9.80
ML-8001	Assorted	10 Per Sheet	2 x 4	—	150	\$9.80

5 sheets each: Pink Glo, Green Glo and Yellow Glo.

FLUORESCENT LABELS - 25 SHEETS PER PACKAGE (LASER PRINTER ONLY)

ML-8101	Pink Glo	30 Per Sheet	1 x 2 $\frac{1}{2}$	—	750	\$10.70
ML-8201	Green Glo	30 Per Sheet	1 x 2 $\frac{1}{2}$	—	750	\$10.70
ML-8301	Yellow Glo	30 Per Sheet	1 x 2 $\frac{1}{2}$	—	750	\$10.70
ML-8102	Pink Glo	10 Per Sheet	2 x 4	—	250	\$10.70
ML-8202	Green Glo	10 Per Sheet	2 x 4	—	250	\$10.70
ML-8302	Yellow Glo	10 Per Sheet	2 x 4	—	250	\$10.70

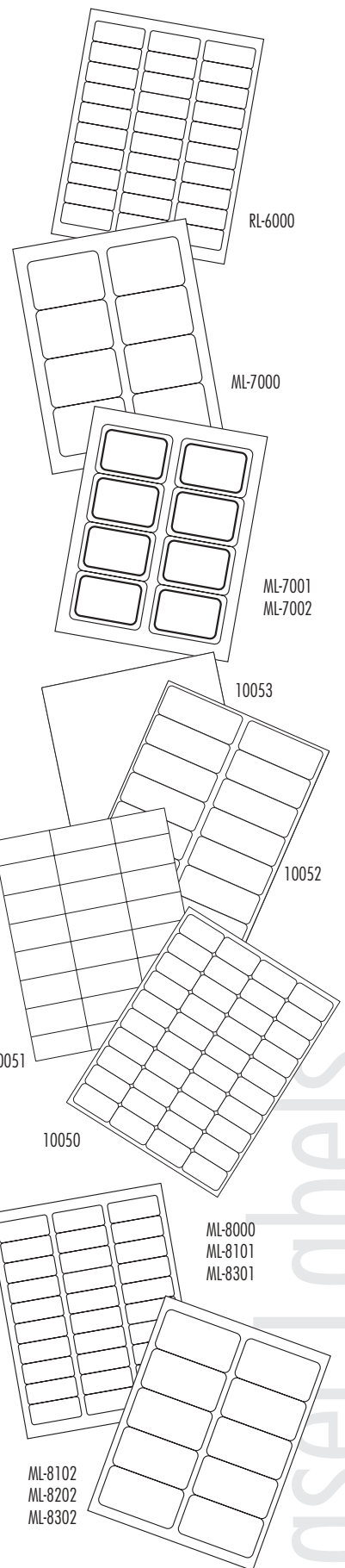

Laser Labels

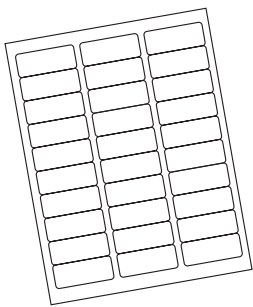

MLL-2610

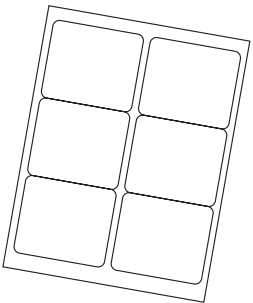

MLL-4033

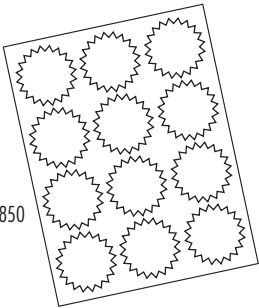

ML-7850

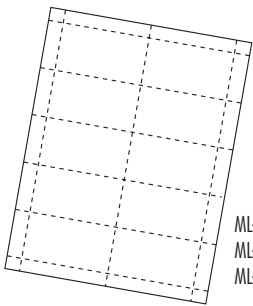

ML-8550
ML-8551
ML-8552

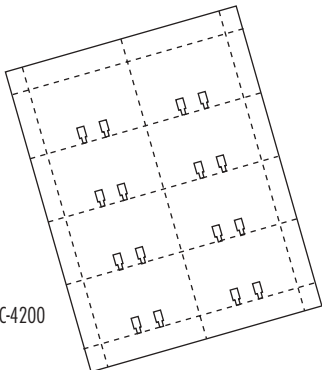

MC-4200

Item Number	Description	Size Inches	Corresponding No. Avery/Dennison	Qty. Labels/ Retail Pkg.	Your Cost
FLUORESCENT LABELS - 100 SHEETS PER BOX (LASER PRINTER ONLY)					
MLL-2610FG	Green Glo	30 Per Sheet 1 x 2 $\frac{1}{2}$	—	3000	\$30.00
MLL-2610FP	Pink Glo	30 Per Sheet 1 x 2 $\frac{1}{2}$	—	3000	\$30.00
MLL-2610FR	Red Glo	30 Per Sheet 1 x 2 $\frac{1}{2}$	—	3000	\$30.00
MLL-2610FY	Yellow Glo	30 Per Sheet 1 x 2 $\frac{1}{2}$	—	3000	\$30.00
MLL-2610FO	Orange Glo	30 Per Sheet 1 x 2 $\frac{1}{2}$	—	3000	\$30.00
MLL-4033FG	Green Glo	6 Per Sheet 3 $\frac{1}{2}$ x 4	—	600	\$30.00
MLL-4033FP	Pink Glo	6 Per Sheet 3 $\frac{1}{2}$ x 4	—	600	\$30.00
MLL-4033FR	Red Glo	6 Per Sheet 3 $\frac{1}{2}$ x 4	—	600	\$30.00
MLL-4033FY	Yellow Glo	6 Per Sheet 3 $\frac{1}{2}$ x 4	—	600	\$30.00
MLL-4033FO	Orange Glo	6 Per Sheet 3 $\frac{1}{2}$ x 4	—	600	\$30.00
MLL-8511FG	Green Glo	1 Per Sheet 8 $\frac{1}{2}$ x 11	—	100	\$30.00
MLL-8511FP	Pink Glo	1 Per Sheet 8 $\frac{1}{2}$ x 11	—	100	\$30.00
MLL-8511FR	Red Glo	1 Per Sheet 8 $\frac{1}{2}$ x 11	—	100	\$30.00
MLL-8511FY	Yellow Glo	1 Per Sheet 8 $\frac{1}{2}$ x 11	—	100	\$30.00
MLL-8511FO	Orange Glo	1 Per Sheet 8 $\frac{1}{2}$ x 11	—	100	\$30.00

PASTEL LABELS - 100 SHEETS PER PACKAGE (LASER PRINTER ONLY)

T-875*	30 Per Sheet	1 x 2 $\frac{1}{2}$	—	3000	\$40.00
T-850*	24 Per Sheet	$\frac{3}{4}$ x 3 $\frac{1}{2}$	—	2400	\$40.00
T-825*	20 Per Sheet	1 x 4	—	2000	\$40.00
T-100*	14 Per Sheet	1 $\frac{1}{2}$ x 4	—	1400	\$40.00
T-125*	10 Per Sheet	2 x 4	—	1000	\$40.00
T-150*	6 Per Sheet	3 $\frac{1}{2}$ x 4	—	600	\$40.00
T-175*	1 Per Sheet	8 $\frac{1}{2}$ x 11	—	100	\$40.00

*Specify pastel color when ordering: Yellow, Blue, Pink or Green.

FOIL NOTARIAL & CERTIFICATE LABELS - 25 SHEETS PER PACKAGE (LASER PRINTER ONLY)

ML-7850	Gold	12 Per Sheet	2 $\frac{1}{2}$ diameter	—	300	\$11.30
---------	------	--------------	--------------------------	---	-----	---------

All Purpose Card Products

WHITE NAME TAG, POST CARD, INDEX CARDS - 50 SHEETS PER BOX (ALL PURPOSE)

ML-8500	Name Tag	8 Per Sheet	2 $\frac{1}{2}$ x 3 $\frac{1}{2}$	5390	400	\$15.50
ML-8520*	Name Tag	6 Per Sheet	3 x 4	5392	300	\$15.50
ML-8575*	Post Card	2 Per Sheet	4 x 6	—	100	\$13.85
ML-8576*	Index Card	3 Per Sheet	3 x 5	5388	150	\$13.85

BUSINESS CARDS - 25 SHEETS PER BOX (ALL PURPOSE)

ML-8550	White	10 Per Sheet	2 x 3 $\frac{1}{2}$	5371	250	\$8.95
ML-8551	Ivory	10 Per Sheet	2 x 3 $\frac{1}{2}$	5376	250	\$8.95
ML-8552	Gray	10 Per Sheet	2 x 3 $\frac{1}{2}$	5377	250	\$8.95

BUSINESS CARDS - BULK PACKED - 250 SHEETS PER BOX (ALL PURPOSE)

ML-8555	White	10 Per Sheet	2 x 3 $\frac{1}{2}$	5911	2500	\$67.15
BC-3122G	Gray	10 Per Sheet	2 x 3 $\frac{1}{2}$	5377	2500	\$67.15

WHITE ROTARY CARD PRODUCTS - 100 SHEETS PER PACKAGE (ALL PURPOSE)

MC-4200*	Rotary File	8 Per Sheet	2 $\frac{1}{2}$ x 4	—	800	\$24.00
MC-5300*	Rotary File	3 Per Sheet	3 x 5	—	300	\$24.00

*Also available in bulk packs (please call for pricing).

Item Number	Description	Size Inches	Corresponding No. Avery/Dennison	Qty. Labels/ Retail Pkg.	Your Cost
-------------	-------------	-------------	----------------------------------	--------------------------	-----------

Ink Jet Printer Labels

WHITE - 25 SHEETS PER BOX (INK JET PRINTER ONLY)

IJ-8025	80 Per Sheet	½ x 1¾	8167	2000	\$6.45
IJ-3025	30 Per Sheet	1 x 2½	8160	750	\$6.45
IJ-2025	20 Per Sheet	1 x 4	8161	500	\$6.45
IJ-1425	14 Per Sheet	1½ x 4	8162	350	\$6.45
IJ-1025	10 Per Sheet	2 x 4	8163	250	\$6.45
IJ-0625	6 Per Sheet	3½ x 4	8164	150	\$6.45
IJ-0125	1 Per Sheet	8½ x 11	8165	25	\$6.45

WHITE - 100 SHEETS PER BOX (INK JET PRINTER ONLY)

IJ-3000	30 Per Sheet	1 x 2½	8460	3000	\$15.65
IJ-2000 new!	20 Per Sheet	1 x 4	8461	2000	\$15.65
IJ-1400	14 Per Sheet	1½ x 4	8462	1400	\$15.65
IJ-1000	10 Per Sheet	2 x 4	8463	1000	\$15.65
IJ-0600 new!	6 Per Sheet	3½ x 4	8464	600	\$15.65
IJ-0100 new!	1 Per Sheet	8½ x 11	8465	100	\$15.65

FILE FOLDER LABELS - 30 PER SHEET - 25 SHEETS PER BOX (INK JET PRINTER ONLY)

IJ-FF30	Assorted*	¾ x 3¼	8166	750	\$14.20
IJ-FF31	White	¾ x 3¼	8366	750	\$14.20

*5 sheets each: Red, Blue, Green, Yellow and White.

White Media Labels and Products

WHITE DISKETTE LABELS - 70 SHEETS PER BOX (ALL PURPOSE)

ML-7500	3½" Disk-White	2¾ x 2¾	5196	630	\$25.75
ML-7600	5¼" Disk-White	1½ x 4	5197	840	\$25.75

WHITE AUDIO & VIDEO TAPE LABELS - 50 SHEETS PER BOX (ALL PURPOSE)

ML-7900	Audio Tape	1¾ x 3½	5198	600	\$25.80
ML-7950	Video Spine	¾ x 5¼	5199	300 sets	\$25.80
	Video Face	1¾ x 3¼	—	—	—
ML-7955	Video Spine Only	¾ x 5¼	—	750	\$25.80

WHITE CD LABELS - 100 SHEETS PER BOX (ALL PURPOSE)

MLL-4540 new!	CD Donut Labels - 2 Per Sheet	Memorex Format*	—	200	\$22.00
MLL-4515 new!	Mini CD Disk Labels - 8 Per Sheet	—	—	800	\$22.00
MLL-4600 new!	CD Crescent Labels - 16 Per Sheet	—	—	1600	\$22.00

*Available in Red, Blue, Yellow (Gold and Silver Foil - Laser Output Only \$36.00/Pkg.)

INK JET CD LABELS - 100 SHEETS PER BOX (INK JET PRINTER ONLY)

375085	Transparent CD Labels - 2 Per Sheet	Memorex Format	—	200	\$62.00
378044	White Gloss CD Labels - 2 Per Sheet	Memorex Format	—	200	\$62.00

CD/DVD SPINE LABELS (ALL PURPOSE) ON A4 SIZE SHEETS

02002	Spine Labels - 37 Per Sheet	.217 x 4.508	—	370	\$5.25
-------	-----------------------------	--------------	---	-----	--------

Hot new item!

APLI CLEAR MEDIA POCKETS - SELF ADHESIVE

2578	CD Pockets	—	—	10	\$6.25
2585	3.5" Diskette Pockets	—	—	6	\$5.40

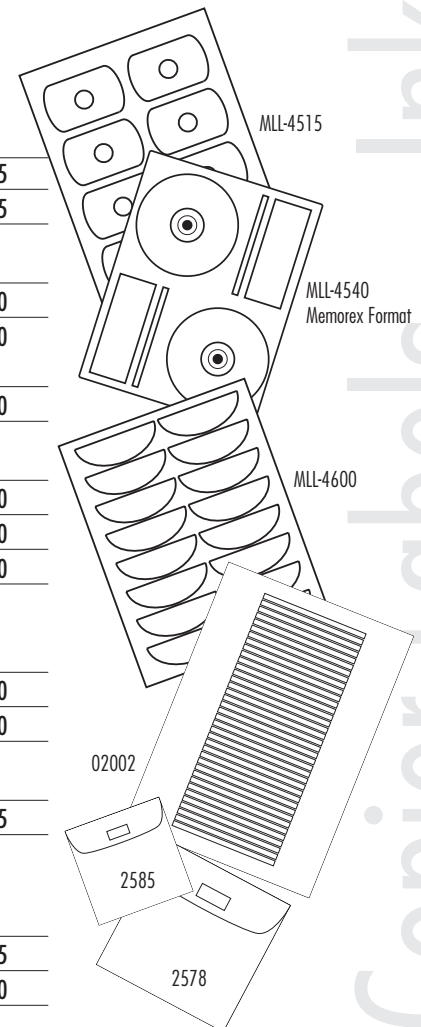
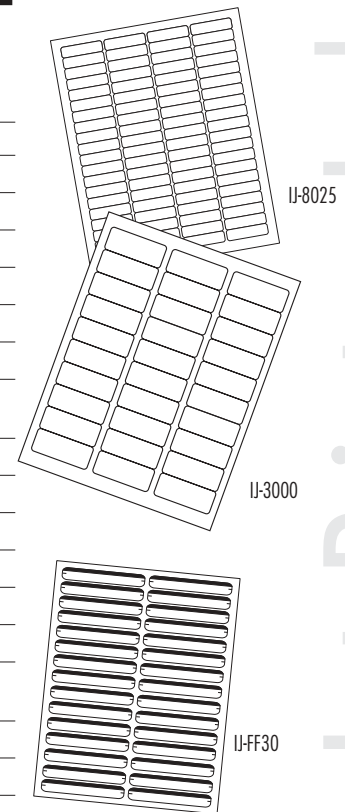

Copier Labels Ink Jet Printer Labels

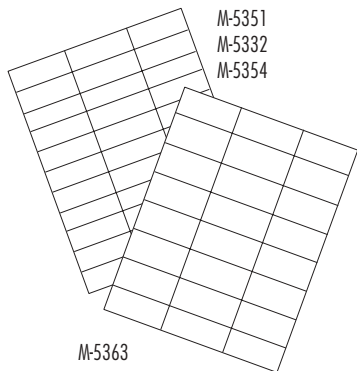
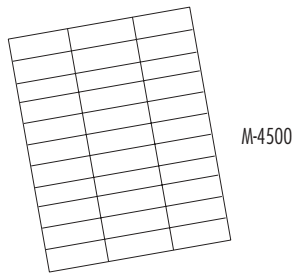

M-5363

Item Number	Description	Size Inches	Corresponding No. Avery/Dennison	Qty. Labels/ Retail Pkg.	Your Cost
-------------	-------------	-------------	----------------------------------	--------------------------	-----------

Copier Labels

TRANSPARENT - 70 SHEETS PER BOX (COPIER ONLY)

M-4500	33 Per Sheet	1 x 2 $\frac{3}{4}$	5311	2310	\$41.55
--------	--------------	---------------------	------	------	---------

WHITE - 25 SHEETS PER BOX (COPIER ONLY)

M-5354	33 Per Sheet	1 x 2 $\frac{3}{4}$	5354	825	\$6.15
--------	--------------	---------------------	------	-----	--------

WHITE - 100 SHEETS PER BOX (COPIER ONLY)

M-5351	33 Per Sheet	1 x 2 $\frac{3}{4}$	5351	3300	\$15.00
M-5363	24 Per Sheet	1 $\frac{3}{8}$ x 2 $\frac{1}{16}$	5363	2400	\$17.60
M-5360	21 Per Sheet	1 $\frac{1}{2}$ x 2 $\frac{1}{16}$	5360	2100	\$17.60
M-5352	10 Per Sheet	2 x 4 $\frac{1}{4}$	5352	1000	\$15.00
M-5353	1 Per Sheet	8 $\frac{1}{2}$ x 11	5353	100	\$15.00

WHITE - BULK PACKED - 250 SHEETS PER BOX (COPIER ONLY)

M-5332	33 Per Sheet	1 x 2 $\frac{3}{4}$	5332	8250	\$36.70
--------	--------------	---------------------	------	------	---------

Postage Meter Labels

Hot new item!

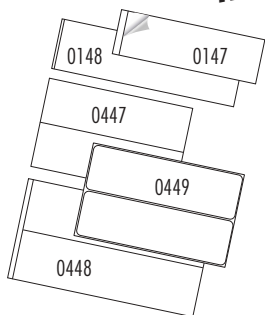

SINGLE WIDE - ULTRA WHITE STOCK - 500 SHEETS/BOX

0147		5.118 x 1.575	—	500	\$16.25
0148		6.496 x 1.772	—	500	\$16.25

DOUBLE WIDE - ULTRA WHITE STOCK - 250 SHEETS/BOX

0447		5.118 x 1.575	—	500	\$12.70
0448		6.417 x 1.772	—	500	\$16.00
0449		5.315 x 1.575	—	500	\$12.75

Hot new item!

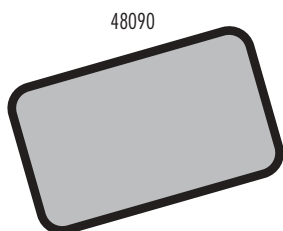

48090

EXHIBITS-U-CREATE™ FROM TABBIES® - 12 SHEETS PER PACKAGE (LASER PRINTER ONLY)

Legal Exhibit Labels • For use with Microsoft® Word.

48090	White	20 Per Sheet	1 x 1.63	—	240	\$6.99
48091	Blue	20 Per Sheet	1 x 1.63	—	240	\$6.99
48092	Yellow	20 Per Sheet	1 x 1.63	—	240	\$6.99
48093	Red	20 Per Sheet	1 x 1.63	—	240	\$6.99
48094	Green	20 Per Sheet	1 x 1.63	—	240	\$6.99
48095	Orange	20 Per Sheet	1 x 1.63	—	240	\$6.99

We carry the full line of Tabbies® products for the medical and legal profession. Call for information or visit our website.

Weatherproof White Labels

20 sheets per package - A4 size sheets 8.268" x 11.69" (LASER PRINTER AND COPIER ONLY)

1226	24 Per Sheet	2.543 x 1.331	—	480	\$18.00
1227	4 Per Sheet	4.134 x 5.827	—	80	\$18.00
1228	1 Per Sheet	8.268 x 11.69	—	20	\$18.00

Item Number	Description	Size Inches	Corresponding No. Avery/Dennison	Qty. Labels/ Retail Pkg.	Your Cost
-------------	-------------	-------------	----------------------------------	--------------------------	-----------

Archival Safe, Acid Free with Acrylic Adhesive

WHITE ARCHIVAL SAFE MEDIA LABELS - 250 SHEETS PER BOX (ALL PURPOSE)

2268	5 ¼ Diskette - 12 Per Sheet	1 ½ x 4	—	3000	\$44.00
3006R*	Imega Zip Disk - 15 Per Sheet	2.35 x 2	—	3750	\$44.00
3007R*	4mm DAT Tape - 15 Per Sheet	2.375 x 1.45	—	3750 sets	\$44.00
	4mm DAT Tape - 15 Per Sheet	2.1 x .275	—		
3008R*	8mm DAT Tape - 56 Per Sheet	2 ⅞ x ⅜	—	14000	\$44.00
LA-3005	CD Donut Labels - 2 Per Sheet	4 ½ Diameter	5824	500	\$35.00
	2 per 8 ½ x 11 sheet, no jewel case labels				
2277	3 ½" Diskette - 15 Per Sheet (non-wrap style)	2 1 ¼ x 2	—	3750	\$44.00

*Removable Adhesive.

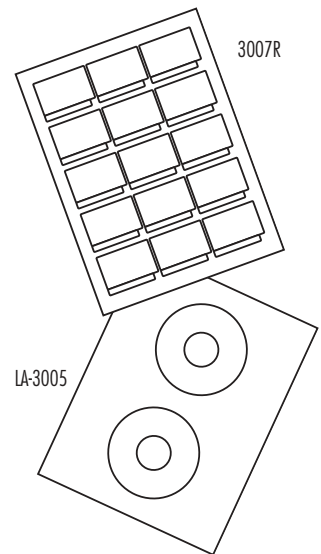

WHITE ARCHIVAL SAFE AUDIO & VIDEO TAPE LABELS - 250 SHEETS PER BOX (ALL PURPOSE)

2281	Audio Tape - 12 Per Sheet	1 ¾ x 3 ½	—	3000	\$44.00
2272	Video Spine/Face - 6 Per Sheet	¾ x 5 1 ¼	—	1500 sets	\$44.00
	Video Face - 6 Per Sheet	1 ¼ x 3	—		

WHITE ARCHIVAL SAFE LABELS - 250 SHEETS PER BOX (ALL PURPOSE)

2264	80 Per Sheet	1 x 1	—	20000	\$44.00
2265	80 Per Sheet	½ x 1 ¾	—	20000	\$44.00
3004	50 Per sheet	1 x 1 ½	—	12500	\$44.00
2228	33 Per Sheet	1 x 2 1 ¼	—	8250	\$44.00
2266	30 Per Sheet	1 x 2 ¾	—	7500	\$44.00
3010	30 Per Sheet	1 x 2 ¾	—	7500	\$44.00
2230	24 Per Sheet	1 ¾ x 2 1 ¼	—	6000	\$44.00
2263	22 Per Sheet	1 x 4 ¼	—	5500	\$44.00
2274	24 Per Sheet	1 ¾ diameter	—	6000	\$44.00
2226	21 Per Sheet	1 ½ x 2 1 ¼	—	5250	\$44.00
3011	20 Per Sheet	1 x 4	—	5000	\$44.00
2262	14 Per Sheet	1 ½ x 4 ¼	—	3500	\$44.00
3003	14 Per Sheet	1 ½ x 4	—	3500	\$44.00
2275	12 Per Sheet	2 ½ diameter	—	3000	\$44.00
2269	10 Per Sheet	2 x 4	—	2500	\$44.00
2225	10 Per Sheet	2 x 4 ¼	—	2500	\$44.00
2229	8 Per Sheet	2 ¾ x 4 ¼	—	2000	\$44.00
2276	6 Per Sheet	3 ½ diameter	—	1500	\$44.00
2261	6 Per Sheet	3 ¾ x 4 ¼	—	1500	\$44.00
2270	6 Per Sheet	3 ½ x 4	—	1500	\$44.00
2260	4 Per Sheet	5 ½ x 4 ¼	—	1000	\$44.00
3002	3 Per Sheet	8 ½ x 3 ½	—	750	\$44.00
2259	2 Per Sheet	5 ½ x 8 ½	—	500	\$44.00
2241	1 Per Sheet	8 ½ x 11	—	250	\$44.00
3009	1 Per Sheet	8 ¾ x 11	—	250	\$44.00

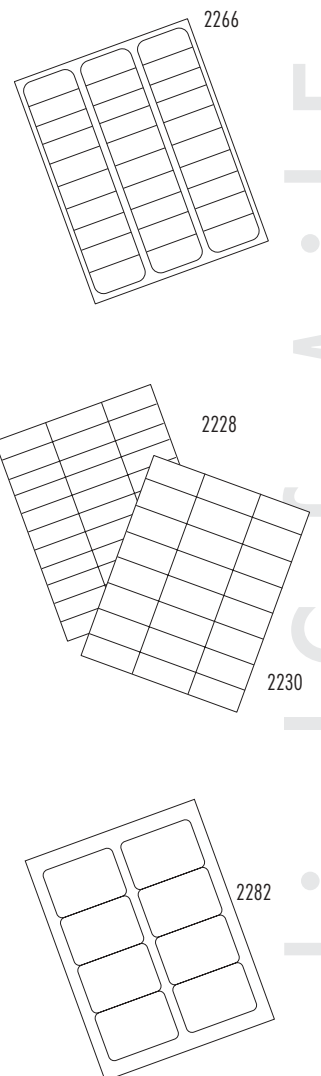

WHITE ARCHIVAL SAFE NAME BADGE LABELS - 250 SHEETS PER BOX (ALL PURPOSE)

2282	8 Per Sheet	2 ½ x 3 ¾	—	2000	\$44.00
------	-------------	-----------	---	------	---------

WHITE ARCHIVAL SAFE FILE FOLDER LABELS - 250 SHEETS PER BOX (ALL PURPOSE)

2271	30 Per Sheet	¾ x 3 ¾	—	7500	\$44.00
------	--------------	---------	---	------	---------

Archival Safe Acid Free

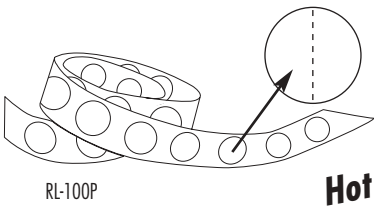

Item Number	Description	Size Inches	Corresponding No. Avery/Dennison	Qty. Labels/ Retail Pkg.	Your Cost
OS-800	Clear Circles 40 Sheets/pkg.	1" diameter	—	600	\$5.95
RL-100P new!	Clear Horizontal Perforation	1" diameter	—	5000/roll	\$26.00

Hot new item!

Recyclable Colored Border Paper

• 20lb white laser paper • Color borders printed with soy-bean based heat resistant ink • Colored borders on both sides of sheet • 100% recyclable • For Xerography, Laser and Offset • 5 reams minimum per order (1 ream=500 sheets)

RCL-101	Yellow	8½ x 11	—	500 Sheets	\$11.75
RCL-103	Salmon	8½ x 11	—	500 Sheets	\$11.75
RCL-105	Pink	8½ x 11	—	500 Sheets	\$11.75
RCL-107	Blue	8½ x 11	—	500 Sheets	\$11.75
RCL-109	Green	8½ x 11	—	500 Sheets	\$11.75
RCL-111	Brown	8½ x 11	—	500 Sheets	\$11.75
RCL-113	Purple	8½ x 11	—	500 Sheets	\$11.75
RCL-115	Gray	8½ x 11	—	500 Sheets	\$11.75
RCL-117	Red	8½ x 11	—	500 Sheets	\$11.75
RCL-119	Teal	8½ x 11	—	500 Sheets	\$11.75
RCL-121	Neon Orange	8½ x 11	—	500 Sheets	\$11.75
RCL-123	Neon Green	8½ x 11	—	500 Sheets	\$11.75

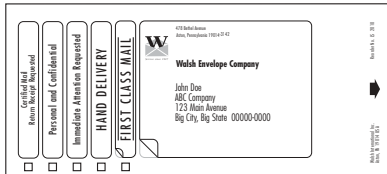

Single Mailing Labels (All Purpose)

Print a single mailing label from your own computer! Carrier sheet is the same size as a #10 business envelope for easy printing and formatting. Works with any envelope printing software. Peel off the correct handling label to affix with the address label. One time typesetting charge, \$20.00.

LS-2010	Personalized imprint	3½ x 4¼	—		
Quantity	Black	1 PMS Color	Black and 1 PMS Color	2 PMS Colors	
1,000	\$125.00/M	\$140.00/M	\$205.00/M	\$230.00/M	
2,500	\$105.00/M	\$125.00/M	\$185.00/M	\$210.00/M	
5,000	\$85.00/M	\$105.00/M	\$165.00/M	\$200.00/M	
10,000	\$75.00/M	\$95.00/M	\$150.00/M	\$190.00/M	

Call for quote on larger quantities.



Service since 1927

Walsh Envelope Company

813 Bethel Avenue
 Aston, Pennsylvania 19014-3145
 800-879-2574 / 610-364-3150 **PHONE**
 800-925-7494 / 610-364-3190 **FAX**
 Professor@walshenvelopes.com **EMAIL**
 www.walshenvelopes.com **WEB SITE**

